



CO-T600

LED Flood Light



Large Stadiums | Airports
Parking Lots | Terminals
Tennis Court | Golf Course
Power stations | Commercial parks



GesCom S.A.

Av. Américo Vesúcio Norte 1940, Of. 1, Conchalí, Santiago
Teléfono 22887 0110 - www.gescomchile.com



Specifications



240/300W



240/300W x2



240/300W x3

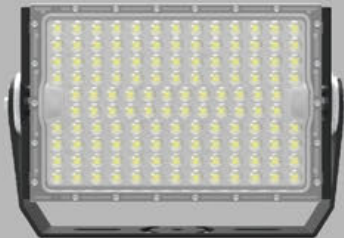

WATTAGE

240/300W

CRI

Ra>70

CCT

2700-6500K

RATED VOLTAGE

AC 100-240V 277V~, 50/60Hz

POWER FACTOR

>0.95

BEAM ANGLE

30°/60°/90°, Asymmetric

IP GRADE

IP66

OPERATING TEMP

-40℃~60℃

WATTAGE	LAMP EFFICIENCY	LAMP LUMINOUS FLUX	WEIGHT	SIZE
240W	170LM/W±5%	40,800LM±5%	5.5KG±5%	344x184x238mm
300W	160LM/W±5%	48,000LM±5%	6.0KG±5%	344x184x238mm

EASY Combination



Light Shield



Side Bracket

Single Module(240W, 300W)

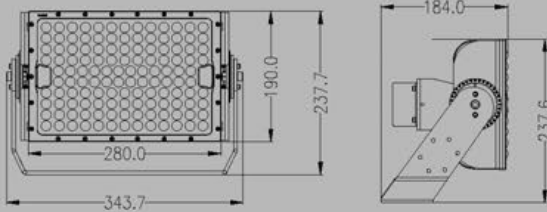

Two Modules(480W, 540W, 600W)

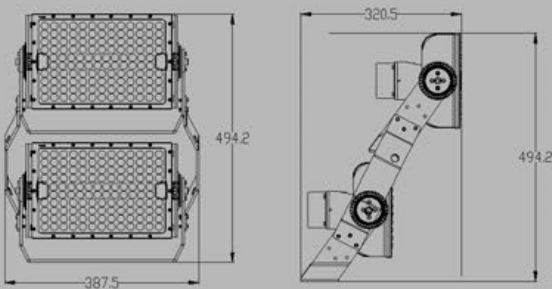

Three Modules(720W, 780W, 840W, 900W)

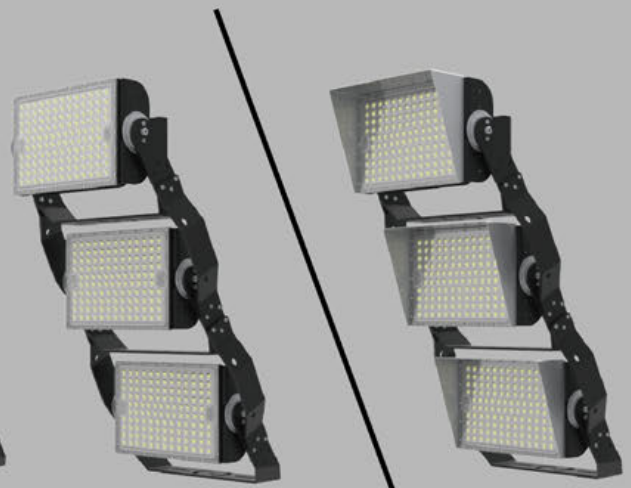
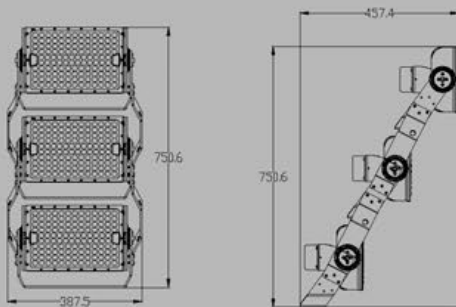

Easy Aiming

Light through the laser pointer, illuminate any corner you want to illuminate.

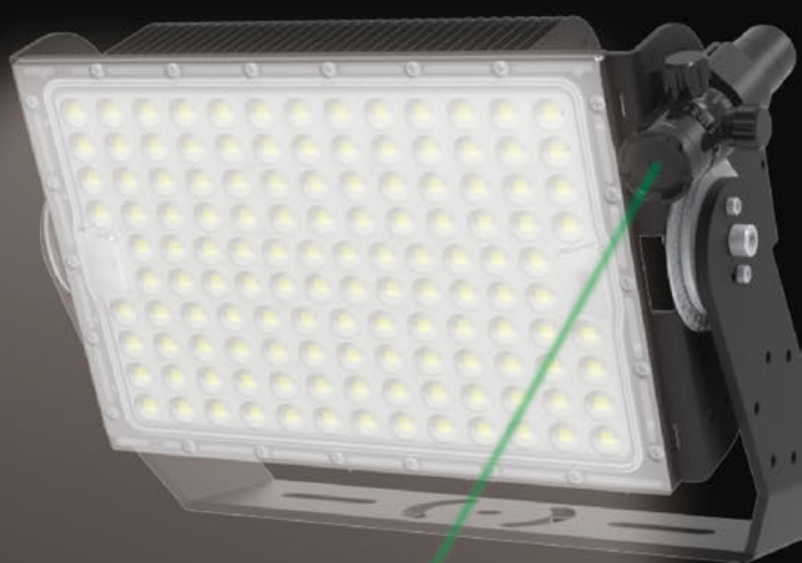

Lightning arrester(20KV)

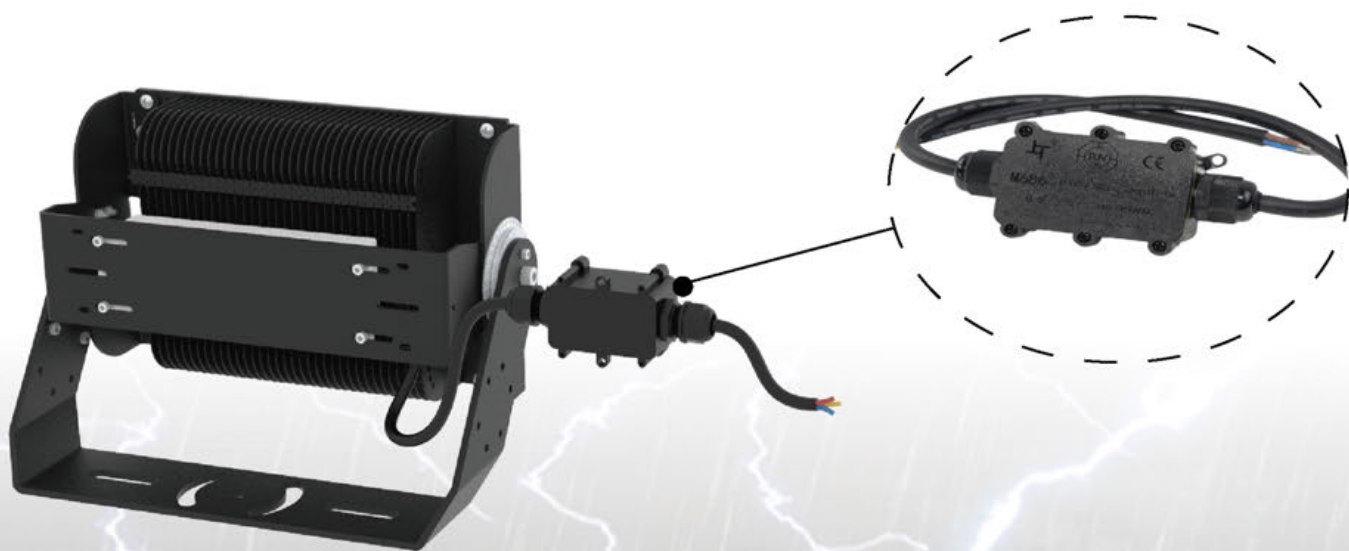

IP66&IK10



Feature

Ultralight & Steady



High Efficiency



Various Angles



Efficient Thermal Management



Energy Saving



Long-life Span



Low Light Attenuation



Module rotatable 360°



Curve screw hole, easy adjustment.

Test

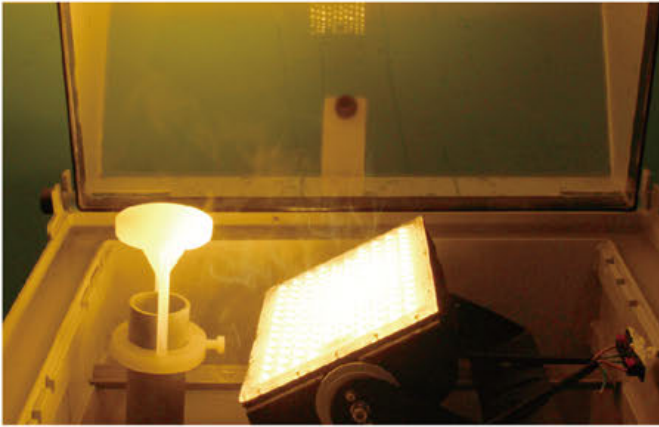

Salt Spray Test

The heat sink processed by oxidization and powder spraying so that it has good corrosion resistance.

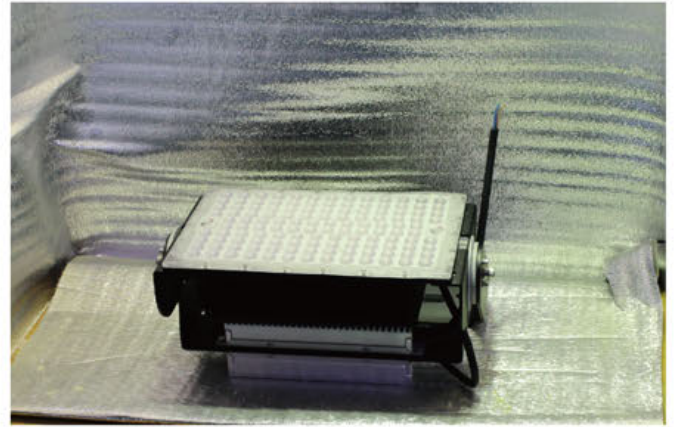

UV Aging Test

The test time is about 720 hours. After test the lamp working regularly, no discoloration appearance , no yellowing of the PC lens.



High-Low Temperature Test

The test equipment opening 2hours, keeping temperature $<-40^{\circ}\text{C}$,the lamp working fine. The test equipment opening 4 hours,keeping temperature $>60^{\circ}\text{C}$, the lamp keep working fine.

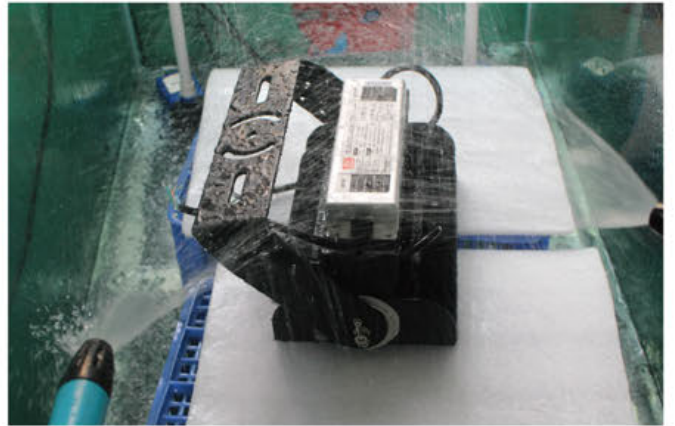

Waterproof Test

Every lamp will be tested the water-proof at least 2 hours before shipment. The semiautomatic test line make it very efficient to shorten lead time.

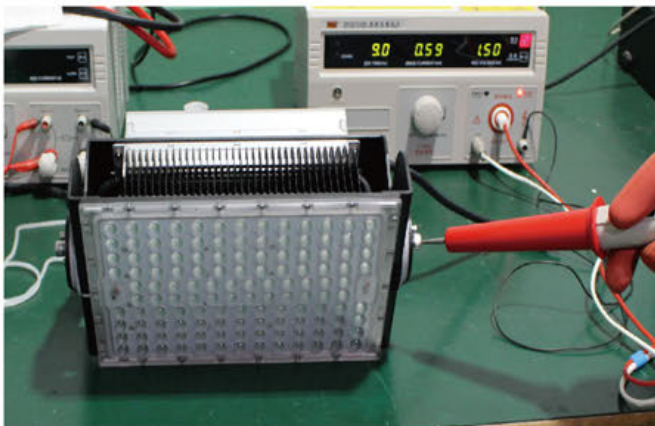

Withstand Voltage Test

Testing whether the withstand voltage is within the specified value, to avoid sudden voltage surges such as short circuit, operation error, fault, etc, causing breakdown or accidents.

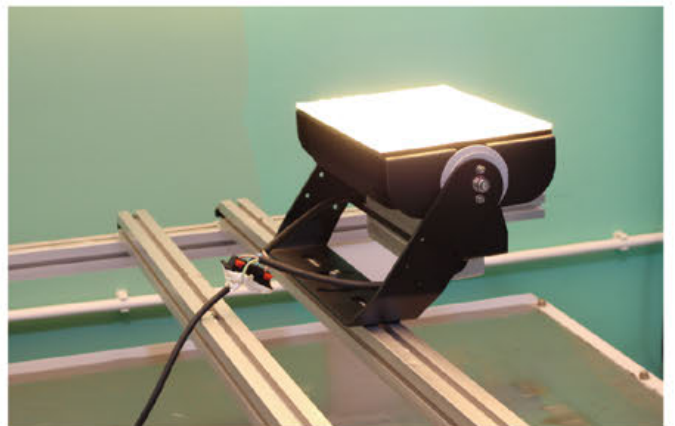

Vibration Test

Vibration test is a simulation of various vibration condition including transportation, installation and using, to ensure system robustness.

DIALux & Light Distribution Optional

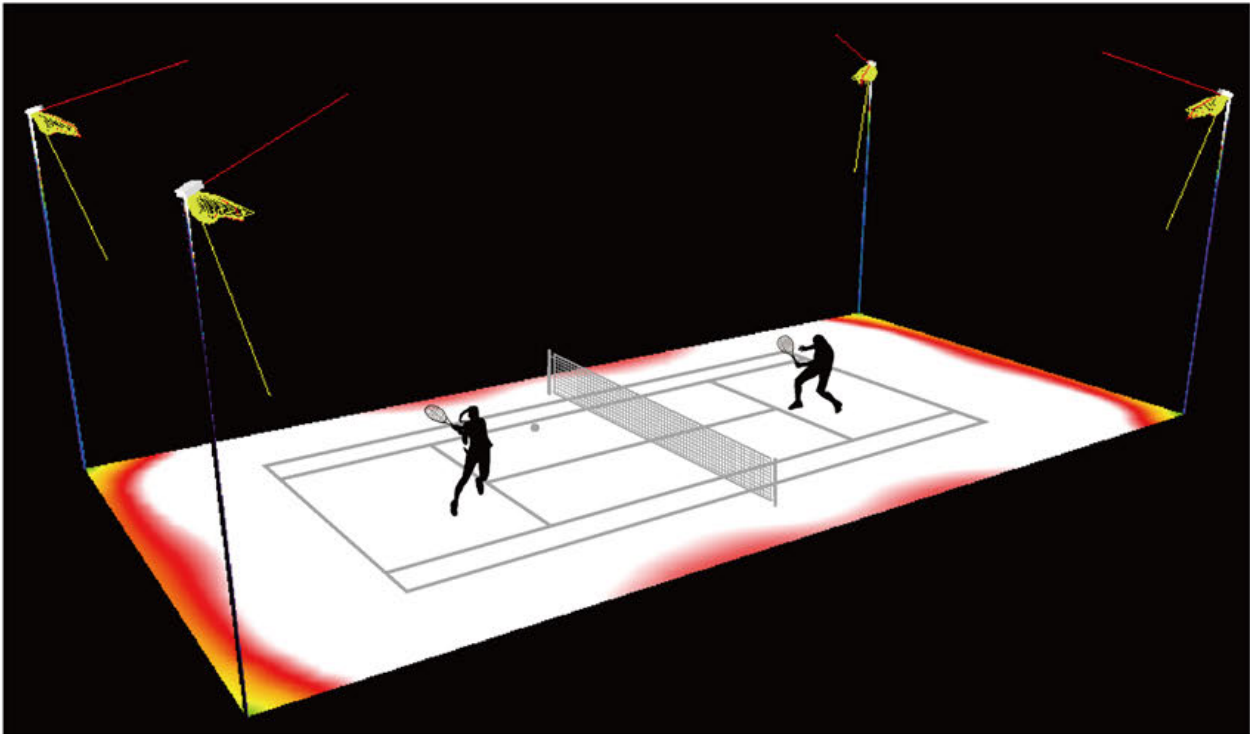

* Standard tennis court, only 4pcs flood light uniformity $U_0 > 0.85$.

30°



60°



90°



Asymmetric-G4 Type



Installation

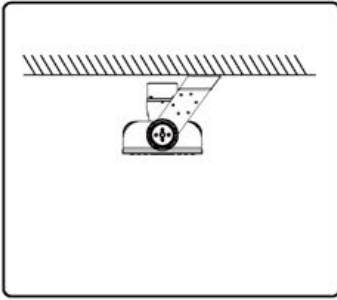

Ceiling Installation

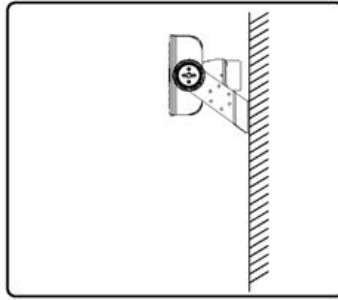

Wall Installation

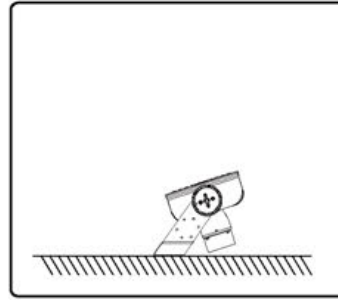

Ground Installation



Pole Installation

Application



Terminal



Airport



Stadium



Portable Lighting

Packaging

WATTAGE	Size Of Box	Cross Weight	Size of Carton	Cross Weight	Box Quantity /Carton
240W	390x295x235mm	6.1kg±5%	605x410x505mm	25.4kg±5%	4
300W	390x295x235mm	6.6kg±5%	605x410x505mm	27.4kg±5%	4

